

# DM Series Miniature Micro Switches



## SPECIFICATION:

Rating : DM1 : 1A 125VAC, DM0 : 0.1A125VAC DM3 : 3A 125VAC	Mechanical Life : 500,000 cycles
Insulation Resistance : > 100M Ω DC500V	Electrical Life : 300,000 cycles
Withstand Voltage : AC500V 1minute	Ambient Temper. Used : -25°C to +65°C
Contact Resistance : ≤ 50mΩ	Ambient Humidity Used : < 85% RH
Soldering Temper : < 245±5°C max, 5 sec.	Operating Force : On request

DM1-00P-110G  
DM3-00P-110G

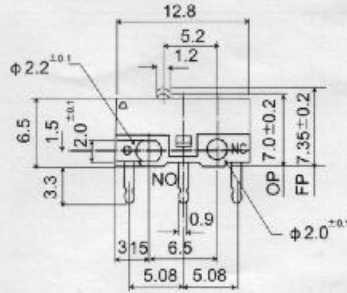

SCHEMATIC

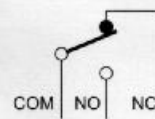

Operating Force (gf):  
60,90,110,130g  
\* \*

\* : standard

DM1-01P-30G  
DM3-01P-30G

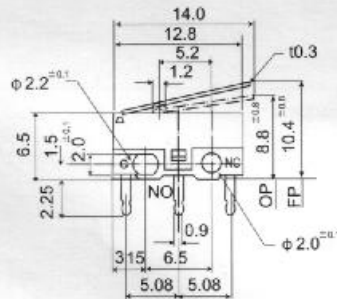

SCHEMATIC

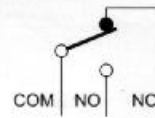

Operating Force (gf):  
20,25,30,40g  
\* \*

\* : standard

DM1-02P-30G  
DM3-02P-30G

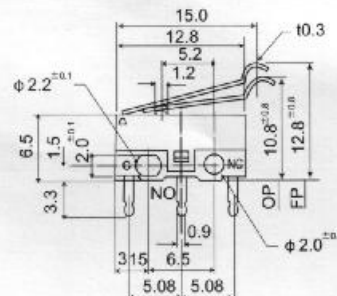

SCHEMATIC

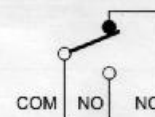

Operating Force (gf):  
20,25,30,40g  
\* \*

\* : standard

DM1-03P-25G  
DM3-03P-25G

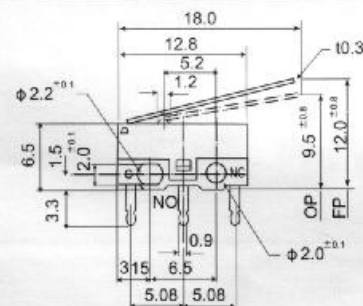

SCHEMATIC

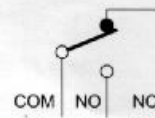

Operating Force (gf):  
15,20,25,35g  
\* \*

\* : standard

## Rolling Type

DM1-13P-25G  
DM3-13P-25G

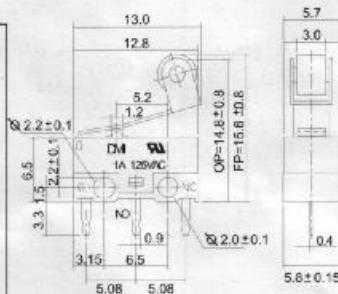

## P TYPE

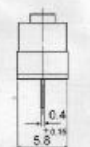
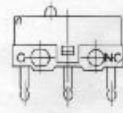

## C TYPE

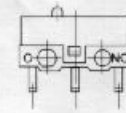

## D TYPE

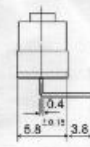
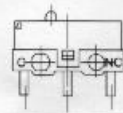

## T TYPE

